

TOPINI CLUBMAXX



DESIGNED & BUILT
IN AUSTRALIA

COMPETITION ENGINE
TC210 CLUBMAXX

MANUAL



CONFORMS TO
KARTING AUSTRALIA NATIONAL
HOMOLOGATION 109H

TOPINI ENGINES

This competition engine falls outside the scope of the Product Emissions Standards legislation 2017 and may only be used in competition racing consistent with the requirements of section 9(2) of the PES Rules.



CONTENTS

ENGINE SAFETY PRECAUTIONS	2
SERIAL NUMBER LOCATION	3
APPROVED ENGINE OIL	3
PRODUCT PARAMETERS	3
MAINTENANCE STANDARDS	4
TORQUE VALUES	4
INTENDED USE	4
ENGINE SWITCH	4
MAINTENANCE SCHEDULE	5
ENGINE OIL	5
RUN IN PROCEDURE	6
AIR CLEANER	6
MUFFLER	7
SPARK PLUG INSTALLATION/REMOVAL	7
VALVE CLEARANCE	7
CARBURETOR	8
JETTING YOUR CARBURETOR	9
READING YOUR SPARK PLUG	11
CLUTCH INSTALLATION/REMOVAL	11
CLUTCH SETUP	12
EXHAUST PIPE INSULATION	13
WET WEATHER AIR FILTER INSTALLATION	14
LONG TERM STORAGE	15
TROUBLESHOOTING	15
LIMITED WARRANTY	16

ENGINE SAFETY PRECAUTIONS

IMPORTANT SAFETY INFORMATION

Most accidents with engines can be prevented if you follow all instructions in this manual and on the engine. Some of the most common hazards are discussed below, along with the best way to protect yourself and others.

OWNER RESPONSIBILITIES

- The engines are designed to give safe and dependable service if operated according to instructions. Read and understand this owner's manual before operating the engine. Failure to do so could result in personal injury or equipment damage.
- Know how to stop the engine quickly, and understand the operation of all controls.
- Never permit anyone to operate the engine without proper instructions.
- Keep children and pets far away from the area of operation.
- **Never modify or change the engine in any way.**

REFUEL WITH CARE

Petrol is extremely flammable, and gasoline vapor can explode. Refuel outdoors in a well-ventilated area with the engine stopped. Never smoke near fuel and keep other flames and sparks away. Always store petrol in an approved container. If any fuel is spilled, make sure the area is dry before starting the engine.

HOT EXHAUST

- The muffler becomes very hot during operation and remains hot for a while after stopping the engine. Be careful not to touch the muffler while it is hot. Let the engine cool before storing it indoors.
- To prevent fire hazards and to provide adequate ventilation for stationary equipment applications, keep the engine at least 3 feet (1 meter) away from building walls and other equipment during operation. Do not place flammable objects close to the engine.

CARBON MONOXIDE HAZARD

Exhaust gas contains poisonous carbon monoxide. Avoid inhalation of exhaust gas. Never run the engine in a closed garage or confined area.

SERIAL NUMBER LOCATION

The engine's serial number, type and variant number are all stamped on the crankcase. You will need this information when ordering parts and when making technical inquiries.

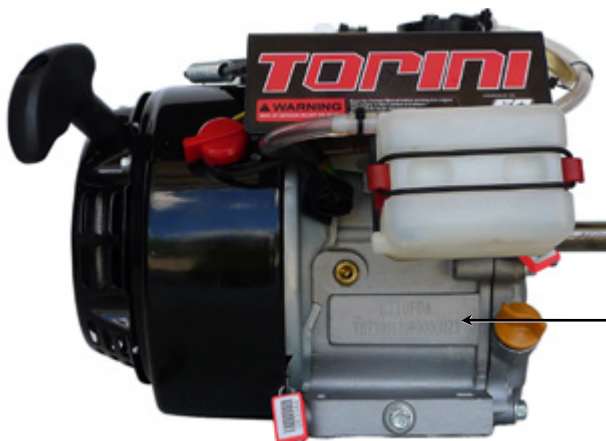

LOCATION OF SERIAL NUMBER

APPROVED ENGINE OIL

KARTING AUSTRALIA HOMOLOGATED ENGINE OIL



RUN IN OIL

Use for the first 1 to 1.5 hours
(Allows engine components to bed in)



RACING OIL

Use only after run-in period
(Friction modified, anti-foaming formula)

PRODUCT PARAMETERS

ENGINE MODEL	TC210 CLUBMAXX
Engine type	Single cylinder, 4-Stroke, Forced Air Cooling, OHV25
Bore x stroke (mm)	70 x 55
Displacement (cc)	212
Compression ratio	8.5:1
Engine oil capacity (L)	0.55
Idle speed (r/min)	1800±100
Starting Mode	Recoil
Lubrication mode	Splash
Cooling system	Forced air cooling
Stopping mode	Grounding
Fuel	Premium Unleaded Petrol (as per KA rule book)
Shaft rotation (PTO)	Counterclockwise (seen from the end of output shaft)
Ignition system	T.C.I. Rev limited to 6,100 rpm
Ignition timing	25° BTDC (fixed)
Carburetor	Horizontal butterfly
Dry weight (kg)	16



MAINTENANCE STANDARDS

PART	ITEM	TC210 CLUBMAXX	
		STANDARD	SERVICE LIMIT
VALVES	VALVE CLEARANCE	IN	0.10±0.02mm
		EX	0.15±0.02mm
SPARK PLUGS	GAP	0.7-0.8mm	--

TORQUE VALUES

ITEM	TC210 CLUBMAXX	
	Thread dia. × pitch	Tightening torque (Nm)
Cylinder head bolt	M8×1.25	32-34
Flywheel bolt	M14×1.5	85-90
Valve lock nut	M6×0.75	8-10
Valve adjusting bolt	M8×1.25	26-32
Crankcase cover bolt	M8×1.25(TR160Q/TR200Q)	8-12 27-30
Magnetic oil drain bolt	M10×1.25	10-13
Spark plug	BPR6ES (NGK)	26-28
Muffler mounting nut	M8×1.25	27-30
Standard torque values	M5 bolt, nut	4-7
	M6 bolt, nut	8-12
	M8 bolt, nut	20-28
	M10 bolt, nut	35-40
	M12 bolt, nut	50-60

INTENDED USE

- This engine has been manufactured as a competition engine it falls outside the scope of the Product Emissions Standards legislation 2017 and may only be used in competition racing consistent with the requirements of section 9(2) of the PES Rules.

Warning: E10 fuel is not suitable for, carburetor & pump diaphragm components.

ENGINE SWITCH

THE ENGINE SWITCH ENABLES AND DISABLES THE IGNITION SYSTEM.

- The engine switch must be in the **ON position** for the engine to run.
- Turning the engine switch to the **OFF position** stops the engine.

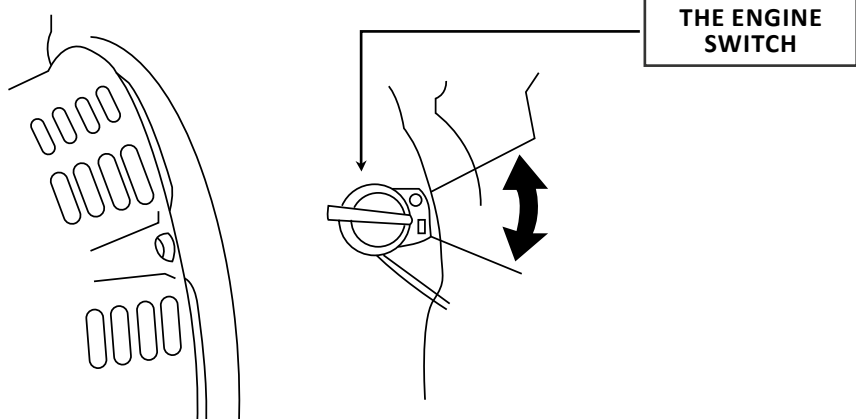

MAINTENANCE SCHEDULE

MAINTENANCE SCHEDULE		EACH USE	FIRST 1.5 HOURS	EVERY 3 MONTHS or 6 HOURS	EVERY 6 to 12 MONTHS or 25 HOURS	EVERY YEAR
RUN-IN OIL (First use only)	Check Level	●				
	Replace		●			
RACE ENGINE OIL	Check Level	●				
	Replace			●		
AIR FILTER	Check	●				
	Clean	●				
	Replace					●
SPARK PLUGS BPR6ES	Clean			●		
	Replace				●	
VALVE CLEARANCE	Readjust			●		
FUEL LINES	Replace	Every 2 Years (2)				
FUEL PUMP	Replace	Every 2 Years (2)				

*** Always use original Torini Replacement parts as per KA Homologation. ***

ENGINE OIL

Oil is the major factor affecting performance and service life. Only use the recommended Torini Race Engine Oil it has anti friction and anti foaming additives specifically designed for splash fed race engines.

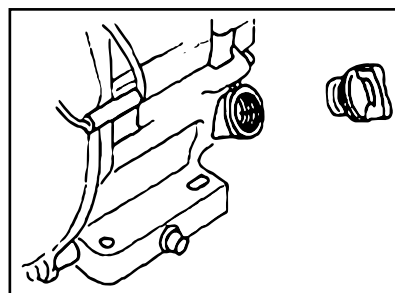

• Engine Oil Capacity:
0.5 L

WARNING

After running in wet weather, oil must be changed ASAP, within 24 hours!

FOR CORRECT OIL LEVEL: FILL BY VOLUME 500ml



RUN IN OIL
Part No. TRO1031
Use for the first
1 to 1.5 hours

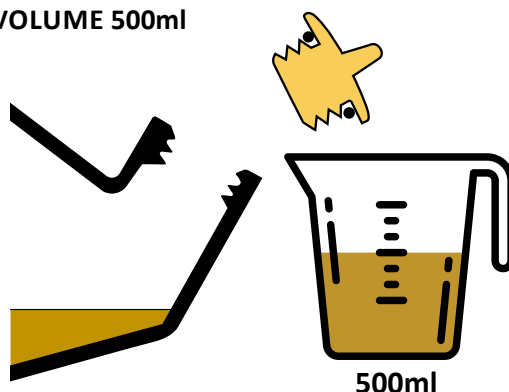

RACING OIL
Part No. TRO1000
Use only after the
run in period!

This is premium quality race engine oil, it has been developed over years of racing experience for air cooled, splash lubricated engines. It contains enhanced friction modifiers and anti-foaming agents blended specifically for Torini race engines.

Note: Do not use Racing Oil prior to run in, the friction modifiers will prevent the bed in process from occurring and you will never realise the full power potential of the engine.

WARNING

Used engine oil contains carcinogenic substances. If repeatedly left in contact with the skin for prolonged periods, it may cause skin cancer. Wash your hands thoroughly with soap and water as soon as possible after contact with used engine oil. Please dispose of used engine oil and the oil containers in a manner that is compatible with the environment. We suggest that you take it in a sealed container to your local waste disposal site or service station for reclamation. Do not throw it in the trash; pour it on the ground, or down a drain.

RUN IN PROCEDURE

Please Consider, unlike other kart engines, you will only run in your Torini race engine once in its entire racing life. How you run it could effect its performance for life, as the manufacturer our engineers recommendation's are listed below.

“ON TRACK ONLY” (DO NOT FREE REV THE ENGINE WITH NO LOAD)

- For the 1st 10-15 minutes drive moderately at varying speeds up to 3800rpm (half throttle). It is critical to vary the RPM for proper camshaft, piston rings and moving component bed in.
- Stop and allow the engine to cool, check that there are no fuel or oil leaks.
- For the 2nd 10-15 minutes drive moderately at varying speeds up to 4800rpm (3/4 throttle).
- Again stop and allow the engine to cool, during this period check the kart over ensuring that all fasteners are secure and that the chain is correctly tensioned with sprockets aligned. (This is a good indication that the engine mount has not moved)
- For the 3rd 10-15 minutes and thereafter drive at race pace or varying speeds up to WOT (Wide Open Throttle) Failure to correctly carry out this step, may inhibit proper piston ring bed in, resulting in poor ring seal, loss of potential horsepower and/or excessive blow-by. Along with your new engine, you have received 1lt of **Torini run in oil** and you should have used 500ml before starting your engine. Once you have completed the first 3 x 15 mins runs we suggest changing this oil and using the remaining 500ml of run in oil supplied. We then suggest you run the engine on track for a further 30-45 minutes at race pace, this will allow engine components to be fully bedded in.

NOTE: Never use the Torini racing oil to run in your engine. The friction modifiers will prevent the bed in process from occurring and you will never realise the full power potential of the engine.

- After the first 1-1.5 hours, your engine is now fully bedded-in, replace the run-in engine oil, with 500ml of the friction modified Torini Racing Oil. The oil contains enhanced friction modifiers and anti-foaming agents blended specifically for your splash lubricated Torini race engine. The friction modifiers work with your piston coating to aide in both the performance and life of your Torini race engine.

AIR CLEANER

A dirty air filter will restrict air flow to the carburetor, reducing engine performance. If the engine is operated in dusty areas, clean the air cleaner more often than specified in the **MAINTENANCE SCHEDULE**.



**PRE FILTER
(FOAM)**



**MAIN FILTER
(FABRIC)**

WARNING

Washing filter element with gasoline or flammable solvents many cause fire or explosion, please use soapy water or nonflammable solvent.

NOTICE

Operating the engine without an air filter element or with a damaged air filter will allow dirt to enter the engine, causing rapid engine wear.

- 1) Remove the foam filter from the main filter element.
- 2) Check both filter elements for signs of damage and replace as necessary.
- 3) Clean both the foam and main element in warm water with detergent or in a nonflammable or high flash point solvent and allow it to dry thoroughly.
- 4) Evenly apply filter oil to the main (fabric) filter element, as well as the foam element, squeeze out as much excess oil as possible from the foam and allow both filters to drain in a clean area overnight.
- 5) Place the foam air filter element over the fabric element, and reinstall the assembled air filter tighten the hose clamp securely.
- 6) Keep the filters covered until next use (filter oil is tacky so dirt and dust will stick to it).

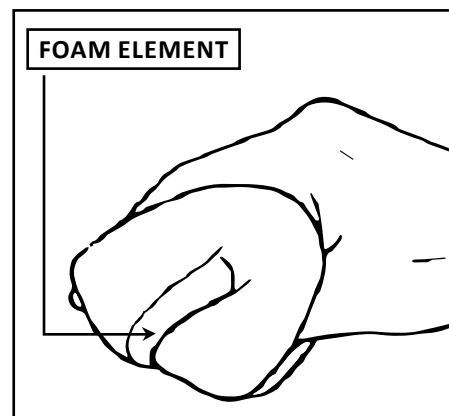

MUFFLER

WARNING

- When running the muffler will heat up, please make inaccessible to passers-by and children.
- Never put any flammable material near the exhaust port.

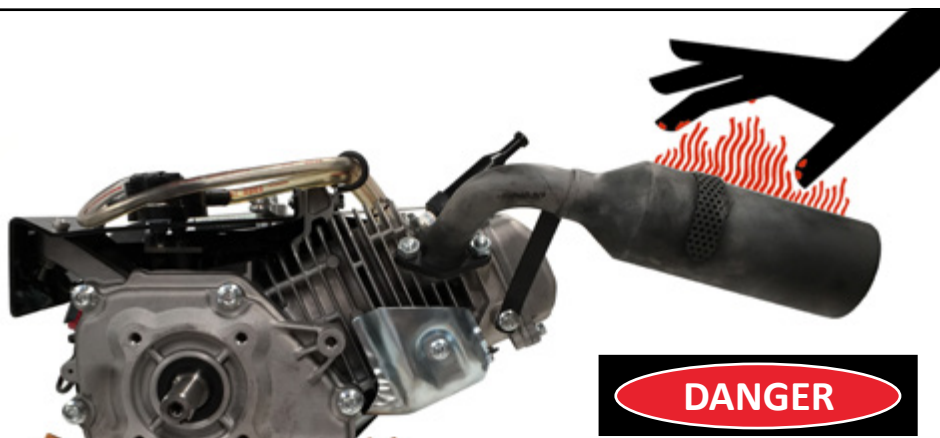

DANGER
WARNING HOT SURFACE

SPARK PLUG INSTALLATION/REMOVAL

APPROVED TYPE: BPR6ES (NGK)

*** Always use BPR6ES Spark Plugs as per KA Homologation. ***

- 1) Remove the spark plug cap.
- 2) Remove the spark plug with a spark plug wrench.
- 3) Visually inspect whether the insulator is cracked or chipped, if so, replace it with a new one, if there are excessive deposits on it; clean it with a wire brush.
- 4) Measure the electrode gap with a feeler gauge. The correct gap is 0.70-0.80mm (0.028 - 0.031 in). If necessary, adjust the gap by carefully tapping (for a too big gap) the electrode or gently forcing up (for a too small gap) the electrode using a slotted screwdriver.
- 5) Make sure the spark plug's sealing washer is in good condition.
- 6) Install the spark plug and use a spark plug wrench to tighten it into the cylinder head.
- 7) When installing the spark plug, in order to prevent cross-threading, first use hand to screw it in the direction as shown by the arrow to install it into the tapped hole in the cylinder head, then tighten with a plug wrench to compress the sealing washer.
- 8) If installing a new spark plug, tighten 1/2 turn after the spark plug seats.
- 9) If reinstalling the used spark plug, tighten 1/8-1/4 turn after the spark plug seats.

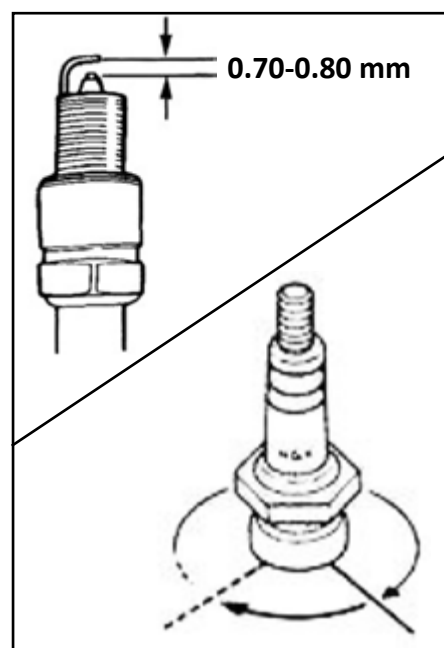

VALVE CLEARANCE

VALVE CLEARANCE INSPECTION AND ADJUSTMENT MUST BE PERFORMED WITH THE ENGINE COLD.

- 1) Remove the valve cover bolts x 4, valve cover and gasket.
- 2) Set the piston just after TDC on the compression stroke this ensures both valves are fully closed and the automatic decompressor is not interfering with setting the valve clearances.
- 3) Insert a feeler gauge between the rocker arm and valve to measure valve clearance.
- 4) If adjustment is necessary, proceed as follows:

VALVE CLEARANCE	IN	0.10±0.02mm (0.004±0.001")
	EX	0.15±0.02mm (0.006±0.001")

- a. Hold the rocker arm pivot with a wrench and loosen the pivot lock nut.
- b. Loosen the rocker arm pivot and turn the rocker arm pivot to obtain the specified valve clearance.
- c. Hold the rocker pivot with a wrench and tighten the lock nut 8–10 Nm only.
- d. Rotate the engine a few times and recheck the valve clearance after tightening the lock nut.

CARBURETTOR

DISASSEMBLY / REASSEMBLY

NOTICE

Before disassembly, loosen the drain screw and drain the fuel from the carburetor. Keep heat, sparks and flame away.

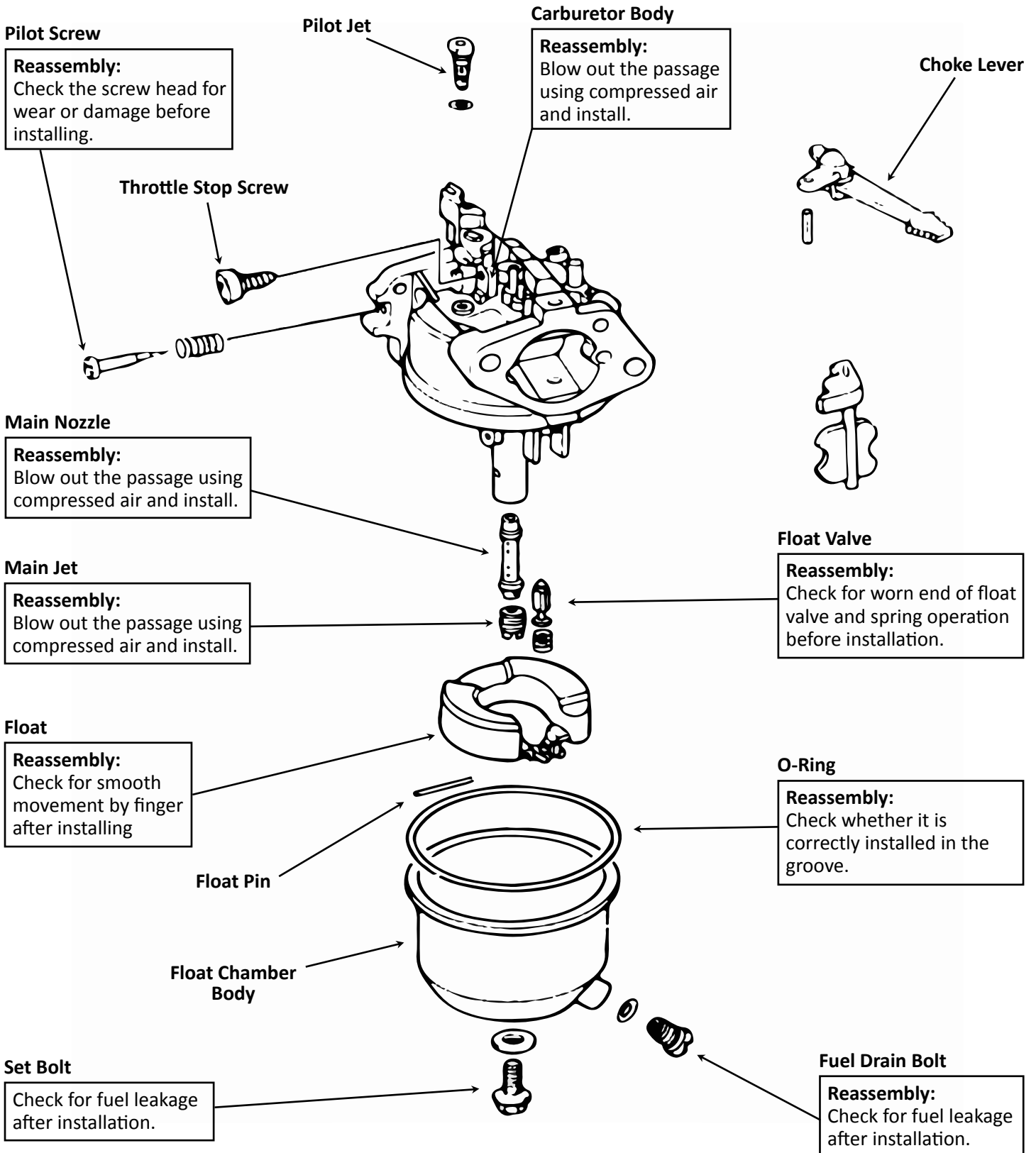

JETTING YOUR CARBURETTOR

JETTING YOUR CARBURETTOR FOR:

- **BEST PERFORMANCE**
- **CORRECT ENGINE TEMPERATURE**
(Cylinder head 230~240°C)
- **INCREASED ENGINE LIFE**

FROM THE FACTORY: The carburettor is supplied with **Main Jet 96 - Pilot Jet 45**. In many cases, this would be considered as a rich setting but is done to protect against running the engine too lean straight out of the box.

AS A STARTING POINT, in areas less than 300m above sea level and with temperatures above 20°C, we suggest starting with a 94 Main Jet and a 40 Pilot Jet.



ADJUSTING YOUR IDLE SPEED: ENGINE IDLE SPEED - 2,000RPM

- **Increase Idle Speed:**
Using a screwdriver, turn clockwise
- **Decrease Idle Speed:**
Using a screwdriver, turn anti-clockwise

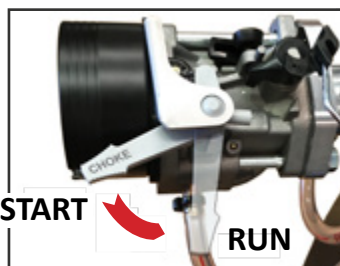

CHOKE LEVER:

The choke lever opens and closes the choke valve in the carburetor.

- **Move the choke lever into the START position for starting.**
- **After starting, slowly move the choke lever to the RUN position.**

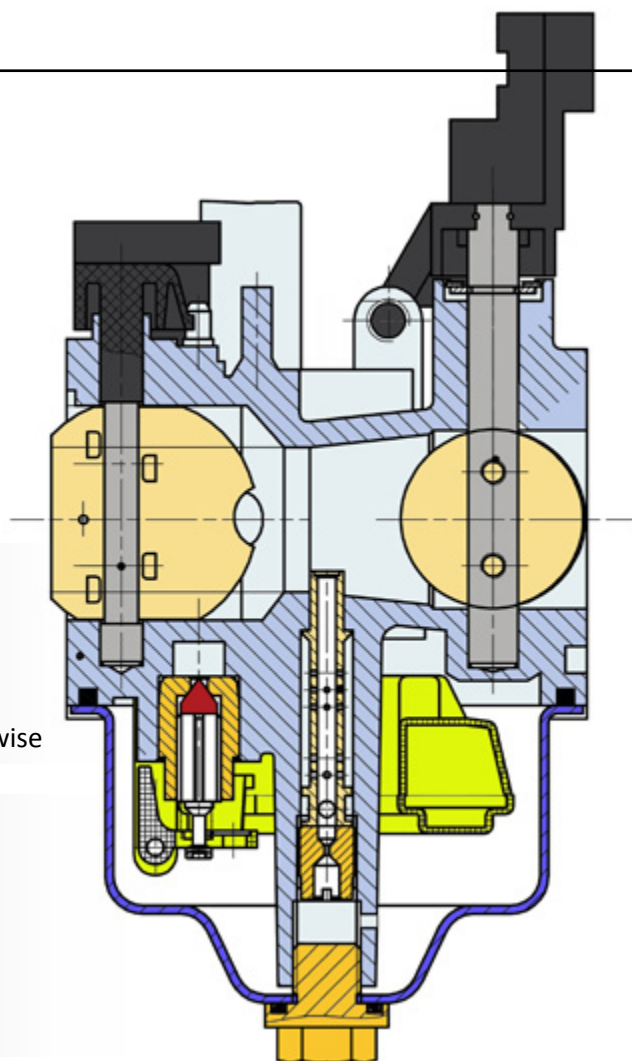

The carburettor mixes fuel and air at a precise ratio, before it goes into the engine to be burnt.

When the fuel air mixture is correct, the engine performs at its best. However this precise fuel air ratio is affected by a number of outside influences, most significantly – altitude (air pressure) and temperature, but is also affected to a lesser degree by humidity.

The factory supplied jetting is a starting point only; for optimum performance you will need to read the spark plug and engine temperature under track conditions to determine the optimum jet sizing required.

Racing on tracks that are more than 300 meters above sea level, or in a different temperature range (+ - 10°C), requires that you re-jet your carburettor to compensate.

Going higher results in lower air pressure (lower air density). When racing at higher elevations your engine is getting less air, so it needs less fuel (a smaller jet) in order to maintain the correct fuel/air ratio. Under such conditions your horsepower will also go down, this is both unavoidable and universal for all competitors, you can figure on losing about 3% of your engine power for every 300m (1000 ft) of elevation.

Now if overnight it gets really COLD! You should also be thinking about re-jetting again! Cold air is dense air, and dense air requires more fuel (a bigger jet). The jet you won the race with yesterday afternoon (when it was hot), will be too lean now, you need a bigger jet to run properly when it's cold. Air temperature makes that much difference! If the temperature is just 10 degrees colder than it was when last you raced, then you risk damaging the engine by running too lean, if you don't change to a larger main jet.

The Main Jet; is the most critical for ensuring full power operation, correct engine temperature and thereby a long engine life.

The Pilot jet and the low-speed idle mixture screw; work together, the pilot jet controls the amount of fuel available and the low-speed idle mixture screw allows you to precisely control the idle mixture being allowed into the engine at idle.

To recap a bigger main jet has a bigger hole in it, which lets more fuel into the engine making it richer! Straight forward enough, but the main jet is also absolutely CRITICAL to high-speed engine operation in another way. Not only does it meter the amount of fuel going into the engine, it also controls the running temperature of the engine as well. If you run too lean the engine will overheat causing damage.

A correctly sized main jet will let the engine make good power for a long time without overheating. The problem is that a main jet just 1 size too small may make greater power, but the engine life will suffer as the operating temperature becomes extreme. A slightly rich mixture burns cooler than a lean one, so be sure the main jet is big enough.

MAIN JET SIZES:
90, 91, 92, 93, 94,
95, 96, 97



PILOT JET SIZES:
40, 43, 45.



JET REMOVAL:

PILOT JET

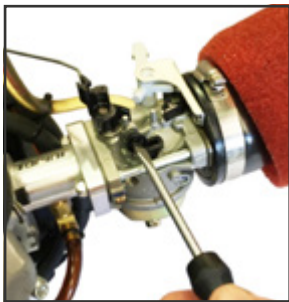

1 Take out the Idle Speed screw

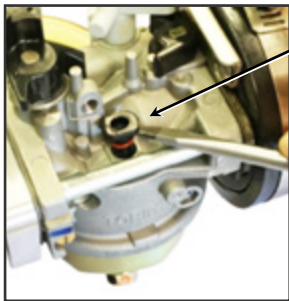

2 Lever the Pilot Jet up gently

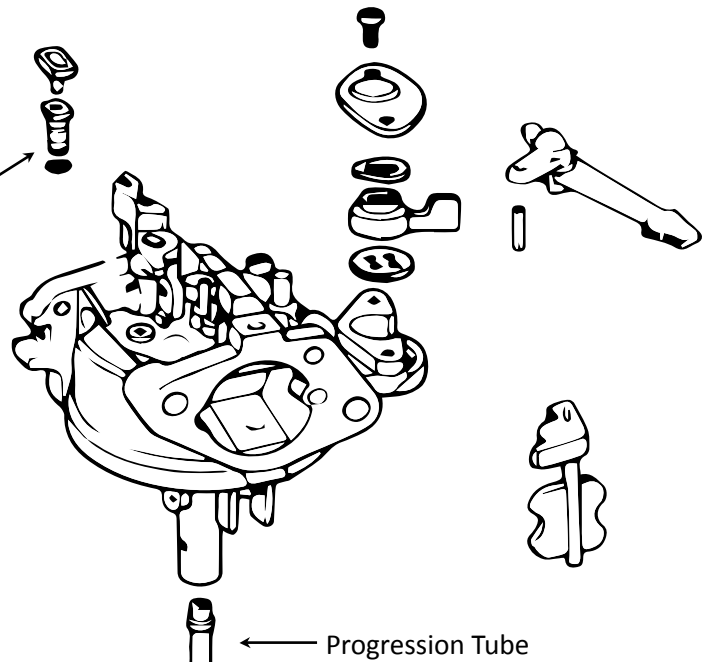

MAIN JET



1 Take out the center fuel bowl bolt (10mm) - and remove the fuel bowl

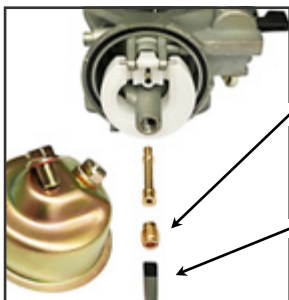

2 Undo the Main Jet

Use a flat blade screw driver
Be careful not to drop the progression tube (it may fall out of the body) once the Main Jet is removed.

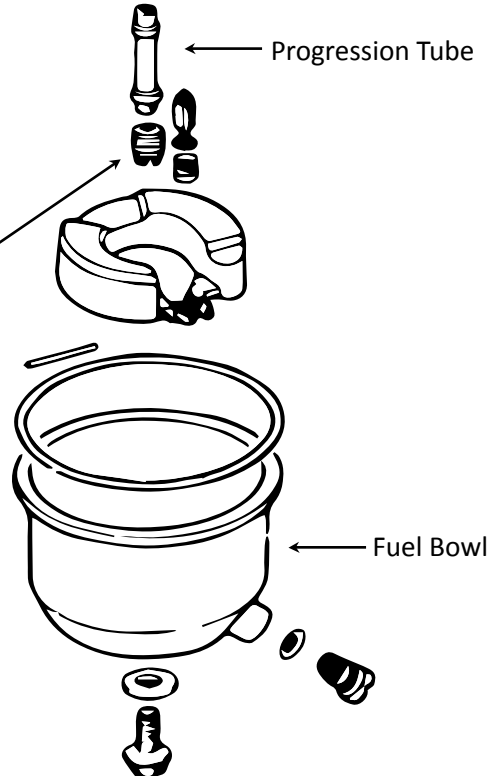

READING THE SPARK PLUG

READING THE SPARK PLUG FOR AIR FUEL MIXTURE:

To obtain an accurate plug reading, run the engine on track for at least 20 minutes, as a new plug will not colour immediately. A spark plug can only be read correctly, if the engine is shut down immediately after entering the pit lane area; do not allow the engine to idle.

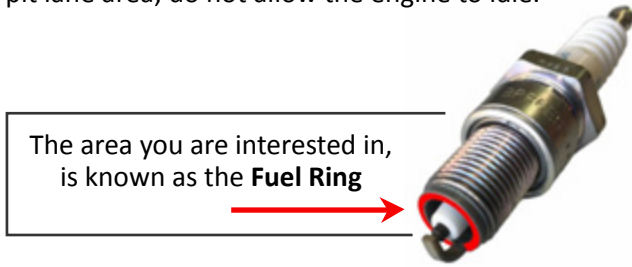

WHAT DOES A SPARK PLUG LOOK LIKE FOR DIFFERENT MIXTURE CONDITIONS?

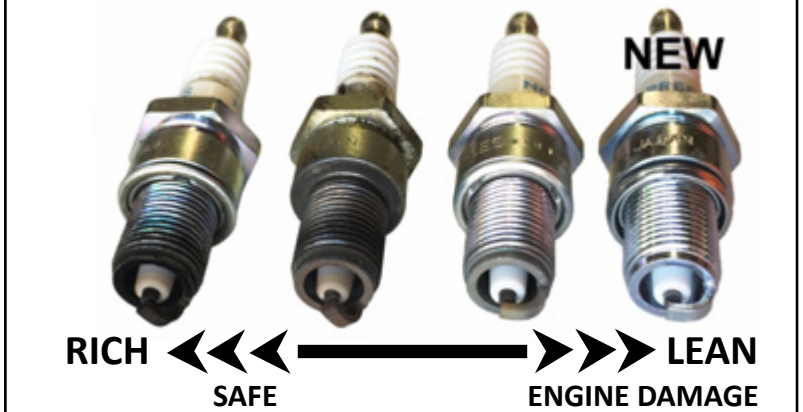

RICH = Sooty, Black in colour	OPTIMAL = Light Grey / tan in colour	LEAN = Extreme white with aluminium specs
--------------------------------------	---	--

CLUTCH INSTALLATION/REMOVAL

To prevent the crankshaft from turning while attaching or removing the clutch, use a long shaft Philips head screwdriver and insert it under the top-plate, from the crankcase side.

Slide the tip of the screwdriver through the hole in the crankcase and into the recess of the flywheel. (as shown below).

Begin by turning the flywheel to align the recess opposite the magnet with the crankcase hole, then insert the screwdriver through the crankcase and turn the crankshaft shaft by hand until contact is felt. This will prevent rotation while undoing or doing up the clutch retaining bolt, torque to 30-32 Nm.

FITMENT GUIDE:

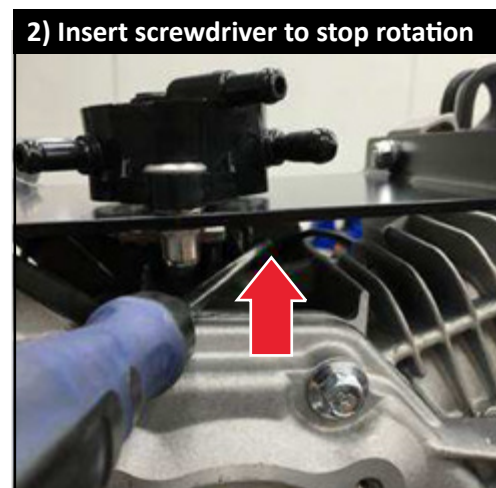
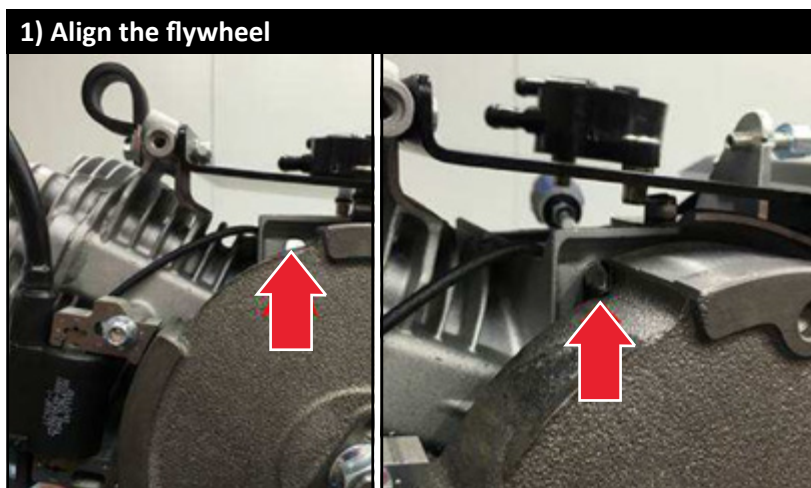

CLUTCH SETUP

P/N: TC-GEL19219

CLUTCH SETUP:

- SPROCKET ORIENTATION
- SHOE SETTINGS
- SPRING TENSION

FUNCTION: The engine crankshaft is connected to the input of the clutch via a keyed shaft, while the output sprocket is connected to the axle by chain. Centrifugal force is used to engage the clutch shoes, thereby transmitting power from the engine to the drive shaft.

RATIONAL: The clutch design allows for inboard or outboard mounting of the output sprocket, 3 different shoe engagement settings, as well as 2 different spring tensions. This allows the clutch to be "tuned" to suit your karts unique characteristics. With correct clutch setup and proper gearing, you will feel an even pull coming out of the corners and constant acceleration on the straights.

CLUTCH SPRING: The tension of the clutch spring and clutch shoe setting will determine the clutch engagement speed and how much clutch slip you will get.

- Engine Idle Speed - 2,000RPM
- Red Spring Engagement Speed - 2,200RPM
- White Spring Engagement Speed - 2,700RPM

SHOE SETTING OPTIONS:

- Rapid Setting** - Minor Clutch Slip
- Moderate Setting** - Medium Clutch Slip
- Slow Setting** - Large Clutch Slip

SPROCKET ORIENTATION: Having the output or drive sprocket mounted outboard is the preferred orientation for a single engine kart.

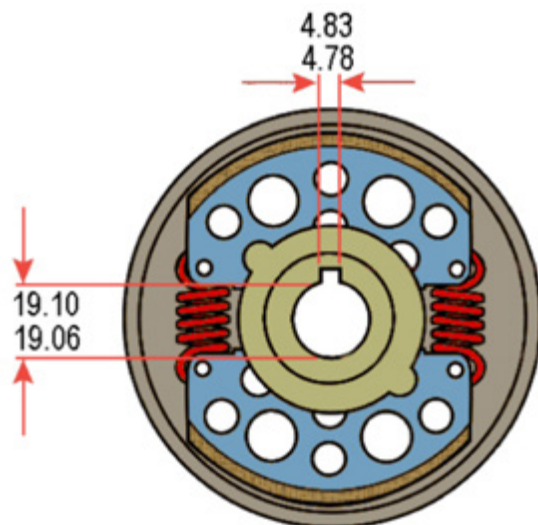

SHOE SETTINGS:

OUTBOARD ROTATION



SETTING 1

RAPID ENGAGEMENT

OUTBOARD ROTATION

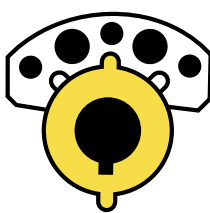

SETTING 2

MODERATE ENGAGEMENT

OUTBOARD ROTATION

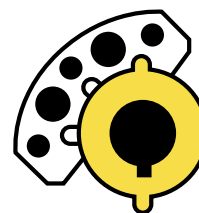

SETTING 3

SLOW ENGAGEMENT

TORINI'S RECOMMENDED SETUP:

SETTING 1

- OUTBOARD MOUNT
- RAPID ENGAGEMENT
- RED SPRINGS

Note - If the kart chatters or shakes, either try a moderate or slow shoe setting or white springs.

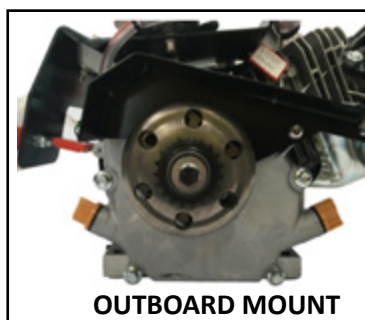

OUTBOARD MOUNT



RAPID ENGAGEMENT

Note - Clutch shown as viewed from the open end.

EXHAUST PIPE INSULATION

Depending on the brand of chassis the header pipe of the exhaust will vary in distance from the seat. We recommend regardless of distance to apply heat insulation to the header pipe in the following manner.

This will do two things.

- Stop heat transfer from the exhaust through your seat adding to driver comfort.
- Stop the potential to accidentally burn a hole in your driving suit.

Applying this kind of insulation to 4 stroke kart engines is common place.



HOW TO GUIDE:

1) Cut a 350mm strip of heat insulation

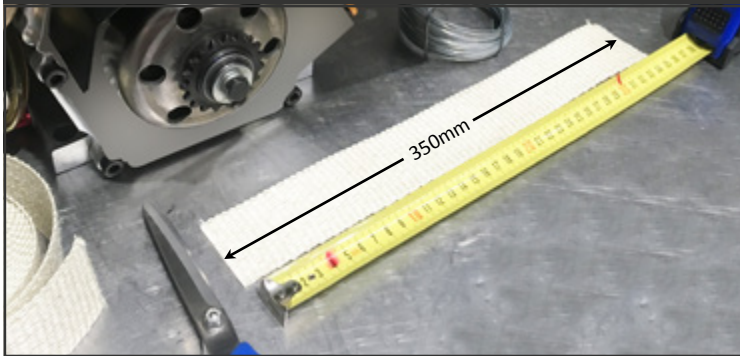

2) Fold material into 4 layers

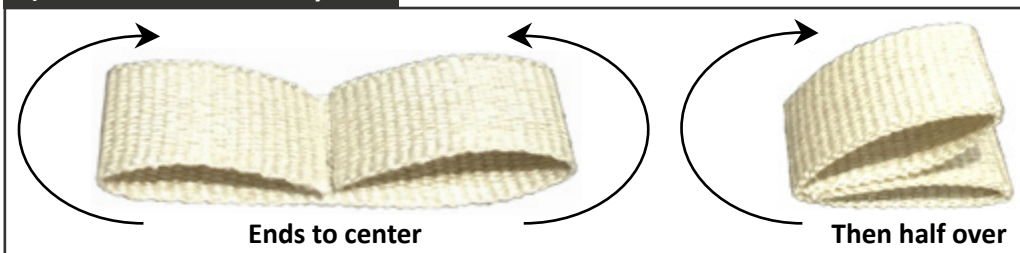

3) Use tie wire to secure the insulation to the top of exhaust pipe

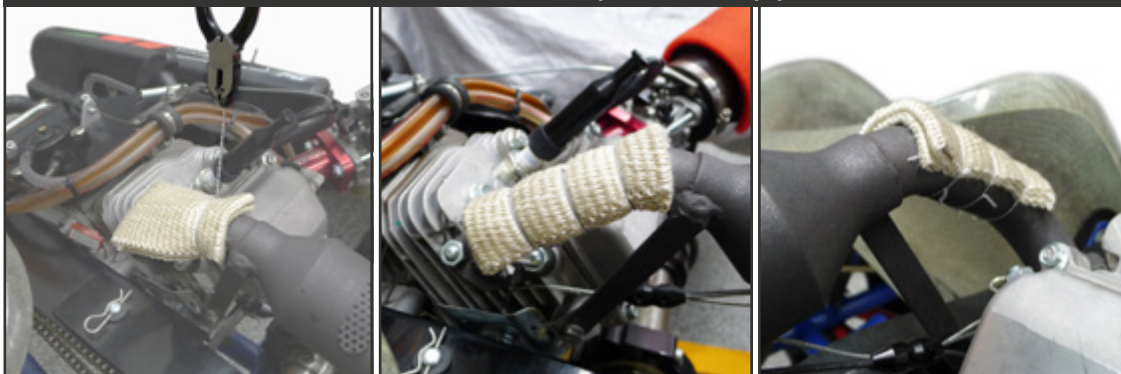

CAUTION

DO NOT WRAP AROUND THE PIPE

- The bottom of the pipe must be left open for air cooling.
- Wrapping the whole pipe will cause it to overheat and fail.



WET WEATHER KIT

NOT INCLUDED IN ENGINE KIT - AVAILABLE SEPARATELY

Essential to prevent engine damage whilst racing in wet conditions - P/N: TCWWK



KIT INCLUDES

- WATER REPELLENT FILTER SOCK
- FOAM FILTER ELEMENT
- SNORKEL ASSEMBLY
- MOUNTING BRACKET
- HOSE CLAMP
- TIE STRAPS (2)



FITMENT GUIDE:

1) Loosen the filter Clamp



2) Remove the standard filter assembly



3) Fit snorkel adaptor to carburetor



4) Thread tie straps through filter bracket



Note: Once mounted, the bracket itself can be left on the engine for use at a moment's notice.

5) Secure the filter assembly to the bracket using tie straps



Note: Ensure hose clamp is done up

WARNING DO NOT USE IN DUSTY CONDITIONS!

The Wet Weather Kit minimises water ingestion by the engine, whilst operating in rainy conditions. The rear facing air intake, uses the karts forward motion to prevent water droplets directly striking the filter intake area while at the same time drawing dry air from one of the most shielded positions available.

- Prevents engine damage due to excessive water ingress into the engine.
- Designed for quick and easy installation or removal under race conditions.
- Maintains near normal engine performance.

LONG TERM STORAGE

When storing the engine during long periods of inactivity:

- Remove and drain fuel bowl, flush out the fuel lines and fuel pump.
- Set the piston to TDC (compression stroke) so valves are closed and valve springs are not compressed.
- Seal off air intake and the exhaust outlet, to prevent moist air entering the engine.
- Store in a clean dry environment.

TROUBLESHOOTING

GENERAL SYMPTOMS AND POSSIBLE CAUSES

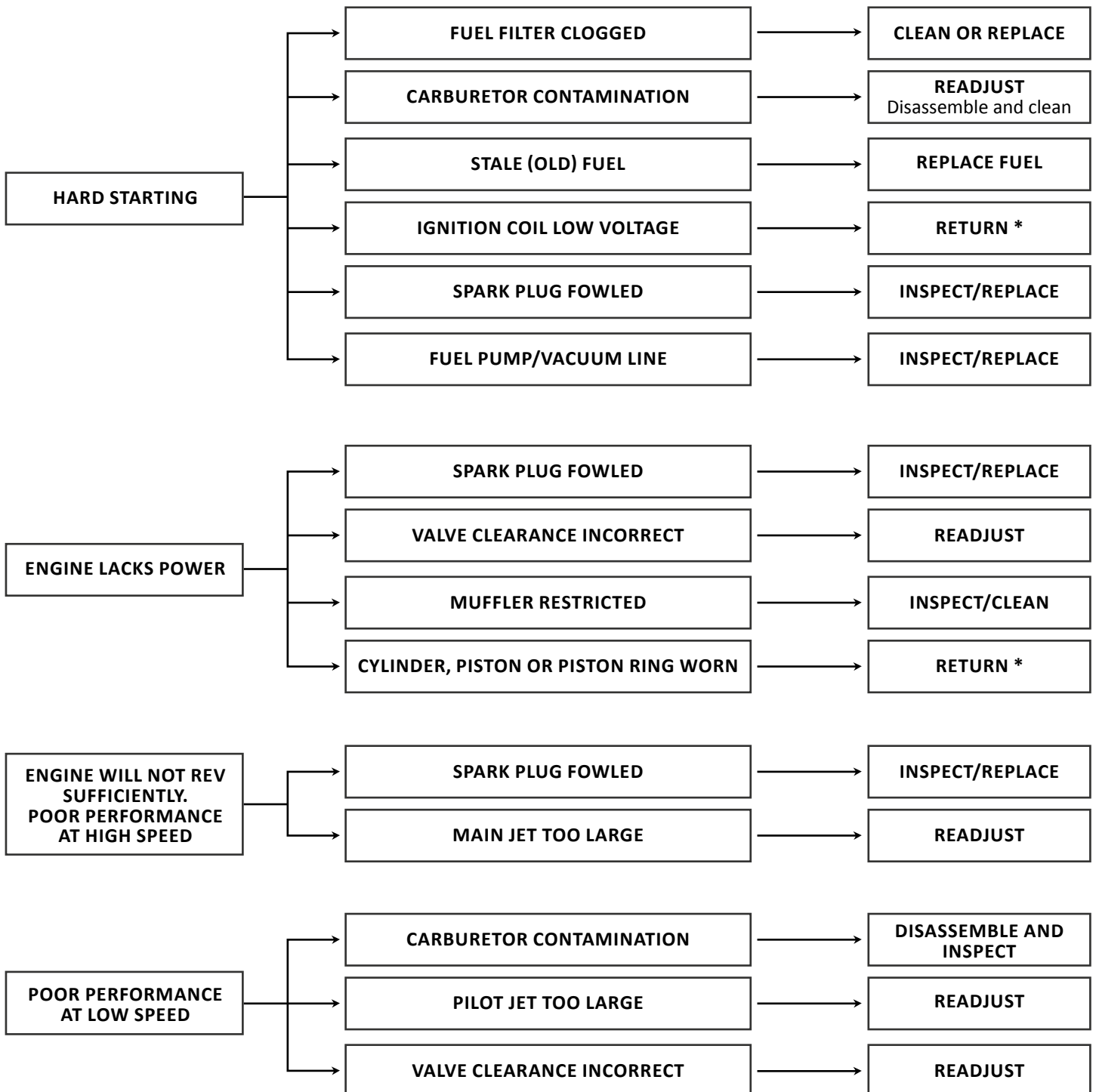

* The return of sealed engines must be made to Torini approved repairers.

LIMITED WARRANTY POLICY

This Limited Warranty applies only to new products* distributed by Austech Industries Pty Ltd ("Austech Industries"). It is a condition of this Limited Warranty Policy that the purchaser read the owner's manual for the product and only use the product to the extent or for the purposes stated therein. The purchaser must also ensure that all servicing requirements are completed as listed in the owner's manual (said servicing is at the owner's expense). We recommend that all servicing is completed by an authorised service agent and that records of said servicing are retained by the purchaser as proof in the event of a warranty claim.

Whilst the owner's manual, packaging, and/or other documentation supplied with Austech Industries' products may provide details in respect of a Limited Warranty, the terms set out herein supersede these matters, and this Limited Warranty applies in their place. This warranty is no less advantageous than otherwise described in such other documentation.

Austech Industries agrees, subject to the terms and conditions specified below, to repair or replace at Austech Industries' cost, the product purchased by you when the product does not perform in accordance with its specifications during the limited warranty period, due to any fault in manufacturing, materials and/or workmanship. Austech Industries is not liable to repair or replace products that the purchaser uses in a manner that is inconsistent with the owner's manual or in the circumstances set out in paragraphs 1.1 – 1.7 below.

The benefits to the purchaser under this warranty are in addition to other rights and remedies under the Competition and Consumer Act 2010 (Cth).

The limited warranty period, within which a defect in the product must appear, commences from the date of purchase and ceases on expiration of the specified term below.

THE LIMITED WARRANTY PERIOD

- Torini Race Engine – 30 Days

The purchaser's attention is drawn to the following

To the extent permitted by law and subject to this Limited Warranty, and as part of the terms of the sale of the equipment or part thereof: Austech Industries shall not be liable for any form of loss, damage, cost, injury or harm of any kind (whether direct, indirect, special or consequential) howsoever arising from the use or supply of the equipment to the purchaser.

Exclusions to Limited Warranty Policy

This Limited Warranty will not apply where the equipment or any part thereof:

- 1.1 Fails due to an accident (including liquid spillage), abuse, misuse, neglect or normal wear and tear;
- 1.2 Has been used in a manner other than for which it was originally designed;
- 1.3 Has been tampered with or is otherwise than as supplied by Austech Industries;
- 1.4 Where any damage, malfunction or other failure of the equipment or any part thereof resulted directly or indirectly from unauthorized persons, adjusting or failing to adjust any part requiring normal maintenance and service (examples include adjustment of tappets, air filter maintenance, lubrication and tightening of screws nuts and bolts);
- 1.5 Malfunctions due to the use of defective or incompatible accessories;
- 1.6 Is damaged by lightning or thunderstorm activity; or
- 1.7 Has been transported to a country where no authorised Service Agents exist.
- 1.8 Has not been used in accordance with Karting Australia Homologation No 109H

Claiming warranty

This Limited Warranty may be claimed on in the following manner:

- 2.1 In order to make a claim under this Limited Warranty, the purchaser must deliver the equipment or any part thereof to an Austech Industries authorised repair agent and pay all costs of transportation and all costs incidental to making a claim under this Limited Warranty. The purchaser must first contact Austech Industries and request the delivery address of an authorised repair agent.
- 2.2 The purchaser must deliver to the repair agent written reasons why the purchaser considers that the purchaser has a claim under this Limited Warranty and must provide all necessary details, including:
 - The place, date and from whom the unit or part was purchased.
 - The unit or part involved, Model and Serial Number.
 - The defect, malfunction or failure in respect of which the claim is being made.
 - Proof of service of the unit or part (if applicable)
 - Proof of purchase in respect of the unit or part.
- 2.3 If the Limited Warranty claim is valid, the repair agent will carry out repairs and return the product at no charge to the purchaser. These repairs are limited to the Limited Warranty fault identified and as such will not include any other faults due to misuse, abuse, failure to maintain, fair wear and tear or the replacement of serviceable items such as oil, spark plugs, air filters, fuel etc.

Our goods come with guarantees that cannot be excluded under the Australian Consumer Law. You are entitled to a replacement or refund for a major failure and for compensation for any other reasonably foreseeable loss or damage. You are also entitled to have the goods repaired or replaced if the goods fail to be of acceptable quality and the failure does not amount to a major failure.

* SP, Scorpion, Torini, are all brand names of products distributed by Austech Industries

Note # Units which are failing to perform in accordance with specifications due to non-warrantable causes will be subject to freight, repair and or quote charges.